

HIGH DENSITY, CONFIGURABLE, 600W AC-DC MEDICAL POWER SUPPLY

MCB600 Series



Certifications



Applications



FEATURES

- » Universal input voltage range (85 – 264 V_{AC})
- » Active PFC, EN 61000-3-2 compliant
- » Input surge current limiting (<20A)
- » High power density (23W/in³)
- » Steady 600W output power available in a 3x5x1.6" form factor
- » Fan speed control function for quiet operation
- » Four (4) slots configurable for up to eight (8) outputs
- » Output modules series and parallel operation
- » Accurate wired current share among paralleled modules
- » Remote output voltage programming / control
- » Remote output current programming / control
- » Output current monitoring signal
- » +/- sense terminal for each slot
- » Output modules +5V, 10mA bias supply
- » Remote single slot or simultaneous inhibit signals
- » Power chassis +5V, 200mA bias supply
- » AC good signal
- » Power good signal for each slot
- » Over temperature, OV, OC and SC protections
- » Medical IEC 60601-1 edition 3.1 compliance
- » 2x MoPP primary-to-secondary protection grade.
- » EN55011, EN 60601-1-2, Class B, conducted radiated emissions.
- » RoHS 3 compliant (Directive EU 2015/863)

MARKET SEGMENTS AND APPLICATIONS

- » Electromagnetic medical equipment
- » Medical / aesthetical laser applications
- » Laboratory analyser equipment
- » Dental care equipment

PRODUCT DESCRIPTION

The MCB600 series of medical rated modular and configurable AC-DC power supplies provide high performance and wide flexibility in an extremely compact package. The series is capable of a steady 600W from a 3 x 5 x 1.6" package, distributed among four independent and isolated slots where any of the six available output modules may be plugged.

The output modules are rated for 150W and are available in single nominal output voltages of 5, 12, 24 and 48V, and two double nominal output voltages of 12 and 24V. Thanks to their extremely wide output voltage adjustability range and the possibility to connect modules of the same type in series and parallel, the MCB600 offers an unrivalled flexibility.

Advanced functions such as remote output current / voltage control and programming, single slot inhibit and all slots inhibit make the MCB600 interactive with complex medical equipment.

Other available signals include power supply AC-Good and output modules Power-Good and +/- Sense Terminals.

The MCB600 comes in a closed package with a built-in speed-controlled fan to ensure the required airflow while maintaining minimal operational noise, which ultimately enhances the power supply service life time.

Output modules of the same type can be connected in parallel in any number in the same chassis without any OR-ing protection.

Paralleling modules across multiple chassis does require OR-ing protection with FET or Diodes. This is also true when operating modules in a N+1 redundant configuration.

Protection features include a fuse on AC lines, input under voltage lockout (IUV), output over-current (OC), output short-circuit (SC), output over-voltage (OV) and over-temperature (OT).

The MCB600 series complies with the 3.1 edition of the IEC 60601-1 safety standard for medical equipment. It offers 2x MoPP means of patient protection and can be used in non-patient contact and non-patient critical equipment.

The MCB600 also complies with the EN55011 EMC Class B limits for conducted and radiated emissions, with the IEC/EN 61000-3, for harmonics, the IEC/EN 61000-4 and IEC/EN 60601-1-2 4th edition for EMC immunity.

Model Coding and Output Ratings

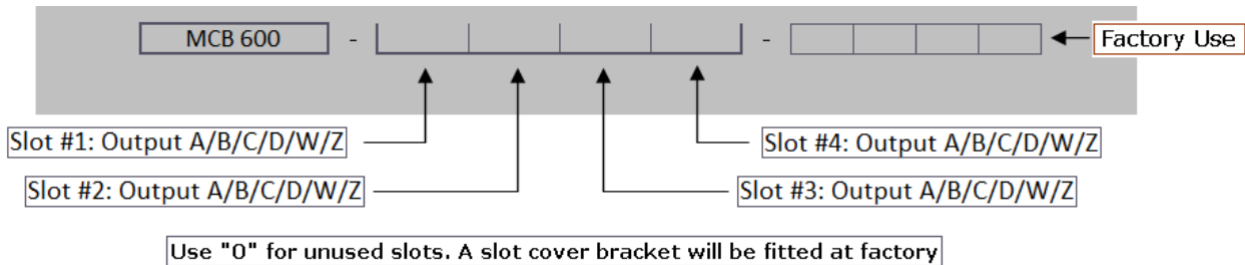

The factory might issue a 4 digit code for a specific configuration which can be used for next and future orders of the same configuration. When ordering an input with no output inserted, simply order “MCB600-XXXX” (Power chassis).

Output Module	Nominal Voltage	Voltage Adjustment	Output Rated Power	Rated Current	Max Current at Nom Voltage	Load Regulation	Over Voltage trip level
A	5 V _{DC}	1.5 to 7.5 V _{DC}	125 W	25.0 A	25 A	±50 mV	9.5 V
B	12 V _{DC}	4.5 to 15 V _{DC}	150 W	15.0 A	12.5 A	±100 mV	18 V
C	24 V _{DC}	9 to 30 V _{DC}	150 W	7.5 A	6.25 A	±150 mV	36 V
D	48 V _{DC}	18 to 58 V _{DC}	150 W	3.75 A	3.13 A	±300 mV	66 V
W	2x 12 V _{DC}	3.3 to 15 V _{DC}	2x 75 W	5.0 A	5.0 A	±50 mV	20 V
Z	2x 24 V _{DC}	15 to 38 V _{DC}	2x 75 W	3.125 A	3.125 A	±150 mV	44 V

0 (Zero) Metal blanking plate for unused slots

Input Specifications

Parameter	Details	Min	Typ	Max	Units
AC input voltage	Nominal range is 100 to 240 V _{RMS}	85		264	V _{RMS}
AC input frequency		47	50/60	63	Hz
DC input voltage		120		300	V _{DC}
Power rating	De-rate by 0.83%/ V _{RMS} below 120 V _{RMS} (600 W at 120 V _{RMS} , 450 W at 90 V _{RMS})			600	W
Input current	At 600 W output and 120 VRMS input			6	A
Inrush current	265 V _{RMS} , cold start			20	A
Fusing	5x20 fast acting fuse			8	A
Input current limit	Maintains power factor		8		A
Efficiency	Configuration dependent		86	89	%
Idle power	All outputs fitted and enabled		28		W
	All outputs fitted and disabled		21		
Power factor	Typical value at 300 W output at 240 V _{RMS}		1.12	1.12	
Hold up	600 W output at 120 V _{RMS} input	17	20	21	ms
UVLO	Turn on only	78		84	V _{RMS}
Over temperature	Internally monitored. Latching	115		125	°C
Reliability	At 40 °C, 80% load			2	FPMH

Signals / Controls and Timing

Parameter	Details	Min	Typ	Max	Units
Bias voltage		4.8	5	5.2	V
Bias current		0		200	mA
Power Good Voltage	PNP open collector with internal 10 kΩ pull down resistor	8	10	15	V
Power Good Current		0		20	mA
Individual inhibit voltage	Apply ≥ 5 V when used as Global Inhibit	2		15	V
Inhibit current	10 kΩ input impedance	0.2		1.5	mA
Global inhibit voltage		3		15	V
Global inhibit current	5 kΩ input impedance	0.6		3	mA
AC_OK voltage		1		4	V
AC_OK current		-10		20	mA
AC_OK warning	See user manual for exceptions	5			ms

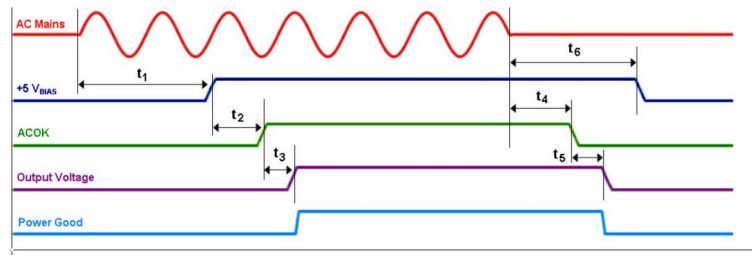

AC Mains asserted – +5V _{BIAS} supply effective: t1 = 300 ms	AC Mains de-asserted – ACOK signal Off: t4 = 15 ms
AC Mains asserted – ACOK signal On: t1 + t2 = 350 ms	AC Mains de-asserted – Power-Good low: t4 + t5 = 20 ms
AC Mains asserted – Power-Good high: t1 + t2 + t3 = 325 ms	AC Mains de-asserted – +5V _{BIAS} supply Off: t6 = 100 ms

Environmental, Installation And Reliability

Parameter	Details	Min	Max	Units
Storage				
Temperature		-40	85	°C
Humidity	Relative, non-condensing	5	95	%
Altitude		-200	5000	m
Air Pressure		54	106	kPa
Operating				
Temperature	Full power De-rating input and output at 2.5% / °C	-20	50	°C
Humidity	Relative, non-condensing	5	95	%
Altitude		-200	5000	m
Air Pressure		69	106	kPa
Acoustic Noise	Variable to input voltage, ambient temperature, load Measured at 1 m from fan intake	35	60	dB(A)
Shock	3000 bumps at 10 g (16 ms) half sine wave			
Vibration	1.5 g, 10 to 200 Hz sine wave, 20 g for 15 min in three axes random vibration			
Installation				
Equipment Class	I			
Installation Category	Category II			
Pollution Degree	2			
Material Group	IIIb (indoor use only)			
Flammability Rating	94V-2			
IP Rating	IP10			
RoHS Compliance	Directive EU 2015/863			
Reliability				
Fan	Precision ball bearing system		2.7	FPMH
Power unit	Input + Transformer modules excluding fan		2	FPMH
Output Modules	See individual output data-sheets		1	FPMH
Warranty			2	Years

Input Voltage And Temperature De-Rating

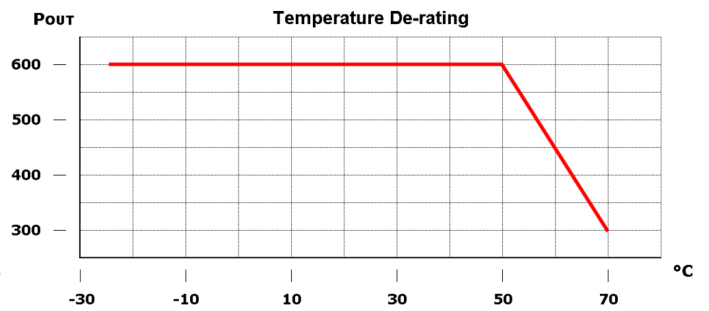
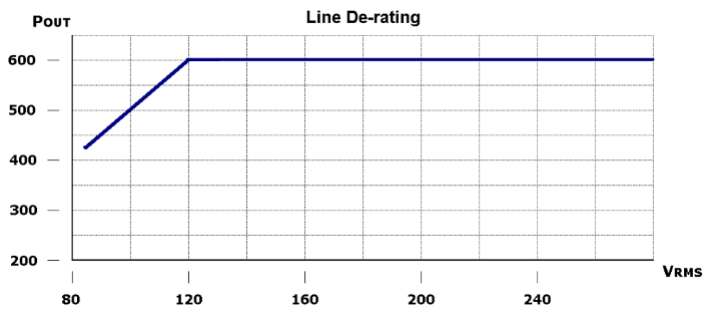

Electromagnetic Compatibility (Emc) – Emissions

Phenomenon	Conditions / Notes	Standard	Equipment/Performance Class
Conducted	115, 230 V _{AC} at maximum load	EN 60601-1-2 (MEE) EN 55011 (ISM)	B
Radiated	115, 230 V _{AC} at 10 m distance	EN 60601-1-2 (MEE) EN 55011 (ISM)	B
Line Voltage Fluctuation and Flicker		EN 61000-3-3	Compliant
Harmonic Current Emission	230 V _{AC} , 50 / 60 Hz	EN 61000-3-2	Class A Compliant

Typical conducted emissions at 115 V_{AC} 60 Hz

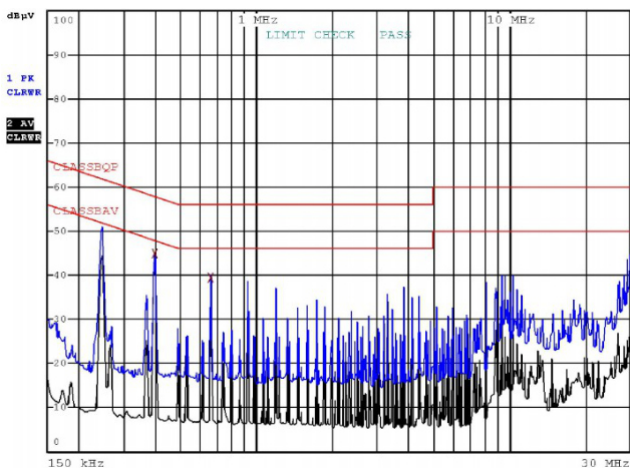

Typical conducted emission at 230 V_{AC} 50 Hz

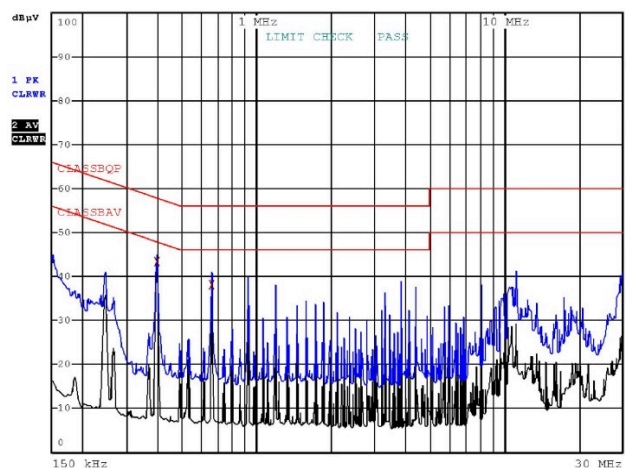

Typical radiated emissions at 115 V_{AC} 60 Hz

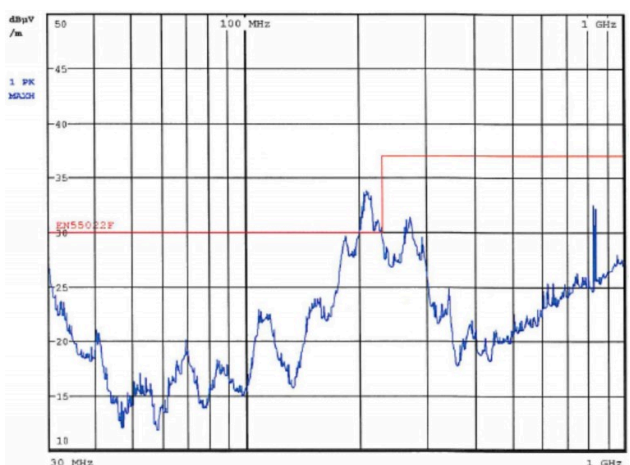

Typical radiated emission at 230 V_{AC} 50 Hz

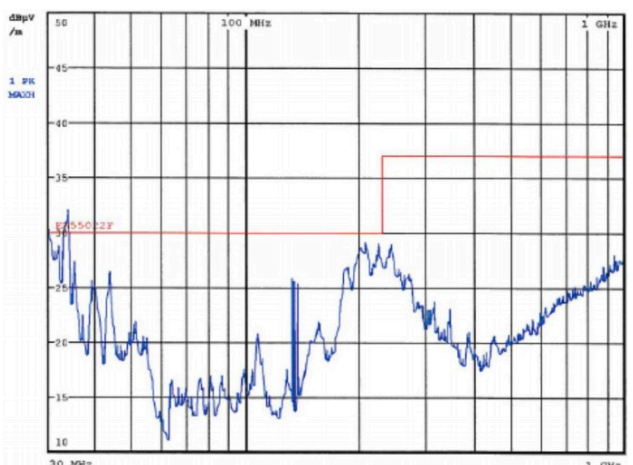

Electromagnetic Compatibility (EMC) – Immunity

Phenomenon	Conditions / Notes	Standard	Test Level	Criteria
Medical Equipment – Electromagnetic disturbance		EN 60601-1-2, 4th edition		
ESD	15 kV air discharge, 8 kV contact discharge, at any point of the system.	EN 61000-4-2	4	A
Radiated Field	10 V/m, 80-2700 MHz, 1 KHz/2 Hz 80% AM.	EN 61000-4-3	3	A
Electric Fast Transient	±4 kV on AC power port for 1 minute	EN 61000-4-4	3	A
Surge	±1 kV line to line; ±2 kV lines to earth on AC power port	EN 61000-4-5	4	A
Conducted RF Immunity	10 V _{RMS} , 0,15-80 MHz, 1 kHz/2 Hz 80% AM.	EN 61000-4-6	3	A
Dips and Interruptions	230 V_{AC}: Drop-out to 0% for 10 ms Dip to 40% for 5 cycles (100 ms) Dip to 70% for 25 cycles (500 ms) Drop-out to 0% for 2 s	EN61000-4-11 EN61000-4-11 EN61000-4-11 EN61000-4-11		A A A B
	115 V_{AC}: Drop-out to 0% for 10 ms Dip to 40% for 5 cycles (100 ms) Dip to 70% for 25 cycles (500 ms) Drop-out to 0% for 2 s	EN 61000-4-11 EN 61000-4-11 EN 61000-4-11 EN 61000-4-11		A A A B

Safety Parameters

Parameter	Details	Min	Max	Units
Isolation Voltage	Primary to Secondary (2x MoPP)	4000		V _{RMS}
	Primary to Protection Earth (chassis) (1x MoPP) Output to Chassis isolation is guaranteed up to 250 V _{DC} Output to Outputs isolation is guaranteed up to 250 V _{DC}	1500		V _{RMS}
Isolation Clearance	Primary to Secondary	7		mm
	Primary to Chassis	2.5		mm
Isolation Creepage	Primary to Secondary	12		mm
	Primary to Chassis	4		mm
Earth Leakage Current	265 V _{AC} , 63 Hz, 25 °C ambient		300	µA

Safety Agencies Approvals

Certification Body	Safety Standards and file numbers	Category
CSA/UL	IEC 60601-1, ANSI/AAMI ES60601-1, CAN/CSA C22.2 No.60601-1 UL: E304543-A3-UL	Medical Electrical Equipment
IEC IECEE CB Certification	IEC/EN 60601-1 edition 3.1 CB Certificate: DK-58241-A1-UL	Medical Electrical Equipment
CE	Directive 93/42/CEE: Safety Requirement of the Medical Device	
	Directive 2014/30/EU: Electromagnetic Compatibility (EMC)	
	Directive EU 2015/863: RoHS 3	

Mechanical Specifications

OUTLINE DRAWING AND DIMENSIONS

Specification	Details	Nominal	Units
Dimensions	Height is 1U	77.7 x 136.25 x 41.0	mm
		3.06 x 5.36 x 1.61	in
Weight	Chassis + input	360	g
	Output modules	60	g
	Chassis + input	13.12	lb
	Output modules	2.12	lb
Mounting	Bottom or side mounting through M4 screws	M4	



N - Neutral
E - Earth
L - Line

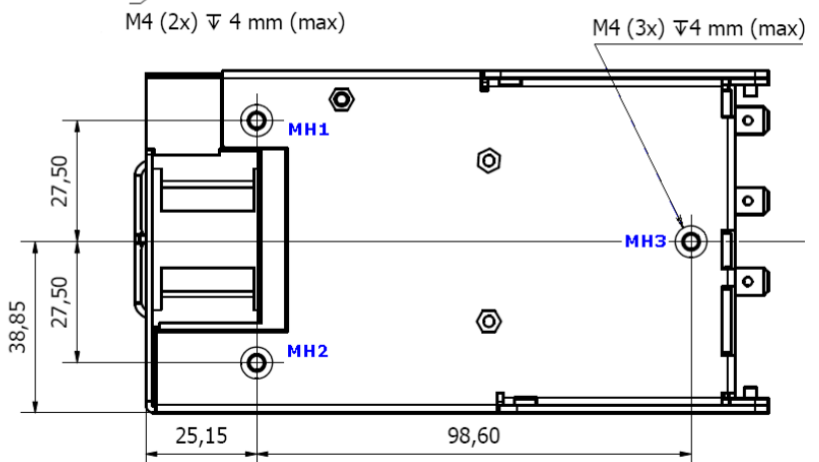
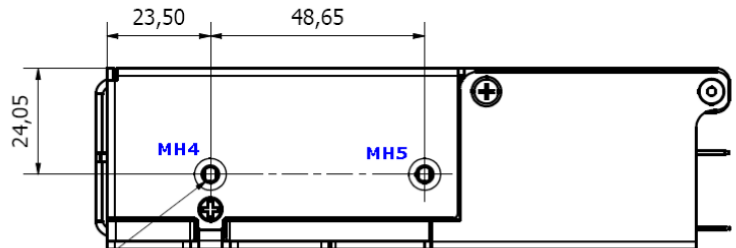
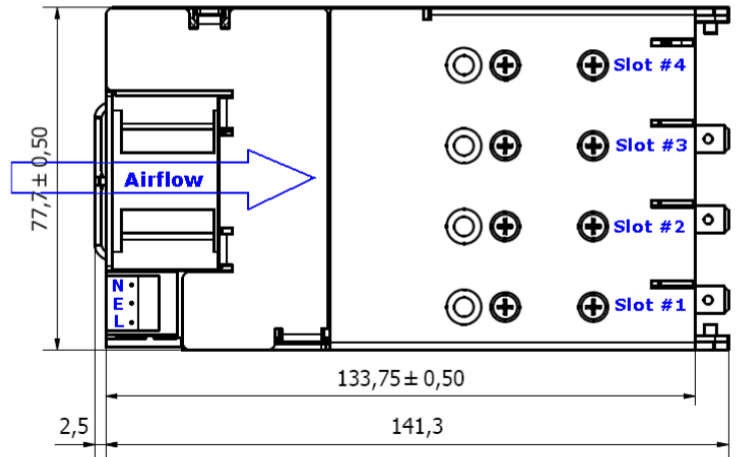
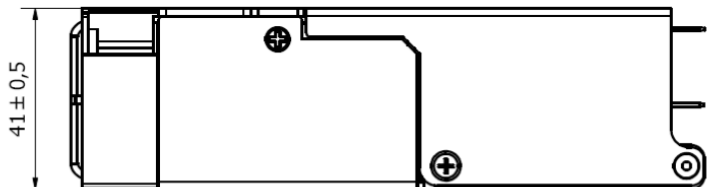

SCREWS	
Power Chassis MH1, MH2, MH3, MH4, MH5	
Screw type	M4
Tightening torque	Tighten to 0.55 Nm (4.87 lb-in) (*)
Penetration depth	4.00 mm max, including chassis
Output Modules x 8	
Screw type	M3x4, C/Sink, Posi, Stainless steel
Tightening torque	Tighten to 0.36 Nm (3.19 lb-in) (*)
Penetration depth	Defined by screw
Secondary cover x 2	
Screw type	M3x4, C/Sink, Posi, Stainless steel
Tightening torque	Tighten to 0.36 Nm (3.19 lb-in) (*)
Penetration depth	Defined by screw
Primary Cover x 2	
Screw type	M2.5x4, C/Sink, Posi, Stainless steel
Tightening torque	Tighten to 0.36 Nm (3.19 lb-in) (*)
Penetration depth	Defined by screw
Fan x 2	
Screw type	M3x30, C/Sink, Posi, Stainless steel
Tightening torque	Tighten to 0.36 Nm (3.19 lb-in) (*)
Penetration depth	Defined by screw

(*) Indicated tightening torque is the one recommended by the threaded insert manufacturer and it shall be regarded as a reference only. Over tightening the mounting screws may result in damaged threads.

Mechanical Specifications

INPUT / OUTPUT CONNECTIONS

Pin Assignment	
Circuit	Details
J1	
1	Neutral
2	Earth
3	Line
J2	
1	Power Good Slot #1
2	Inhibit Slot #1
3	Power Good Slot #2
4	Inhibit Slot #2
5	Power Good Slot #3
6	Inhibit Slot #3
7	Power Good Slot #4
8	Inhibit Slot #4
9	Global Inhibit
10	AC OK
11	+5V 200mA, Bias Supply
12	COM
J5	
1	-Sense
2	+Sense
3	Voltage Control
4	Current Control Current Sharing Current Monitor
5	COM
6	+5V 10mA, Bias Supply
J3	
Positive Output (+)	
J4	
Negative Output (-)	

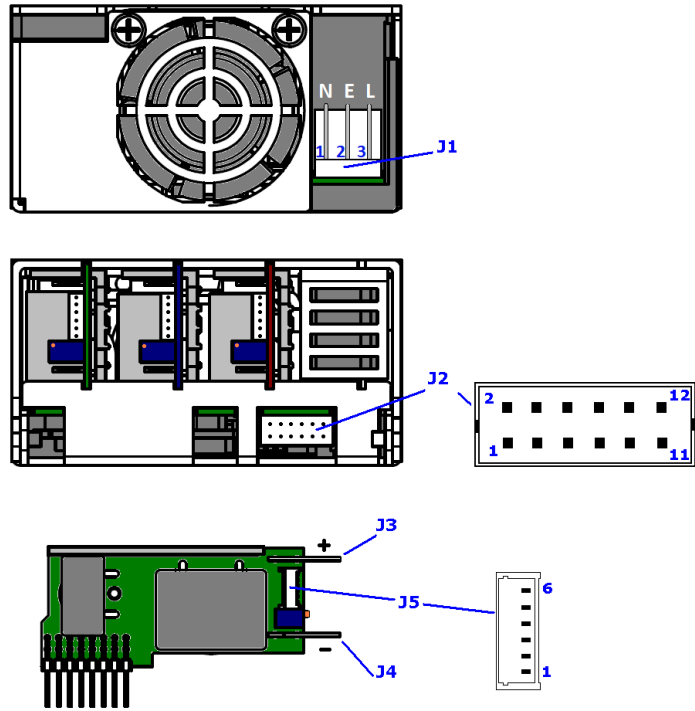

COUNTERPART CONNECTORS				
Reference	Details	Manufacturer	Housing PN	Terminal PN
AC Mains Input J1	5.08 mm (0.200 in), 3 circuits housing, with friction lock, or, any direct equivalent.	Molex	10013036	8701031
Power Unit Signal J2	Crimp terminal, 18-24 AWG, tin finish, or, any direct equivalent. 2.00 mm (0.079 in) 12 circuits housing with locking ramp, or, any direct equivalent.	Molex	511101260	503948051
Output Power J3/J4	Crimp terminal 24-30 AWG, gold finish, or, any direct equivalent. Quick Disconnect Receptacle compatible with PCB mounting TAB, size 0.80X6.35 mm. Tin finish.	Vogt AG Tyco Electronics	NA	3967 640907-1
Output Signal J5	1.25 mm (0.049 in), 6 circuits housing, Crimp terminal 28-32 AWG, tin finish, or, any direct equivalent	Molex	510210600	500588000

Notes:

Output power terminal and wire current rating must exceed maximum short circuit output current (OP-A: 25*1.25 = 31.25 A)
Direct equivalents may be used for any connector parts
All cables must be rated 105°C min, equivalent to UL1015.

Dual Output Modules - OPW / OPZ - Pin Assignment and Outline drawing

Circuit	Description
V1 and V2 Output Voltages MOLEX 0430450400	
1	-V1
2	-V2
3	
4	
Signals MOLEX 0530480510	
1	S- (V2)
2	S+ (V2)
3	Not connected
4	S- (V1)
5	S+ (V1)

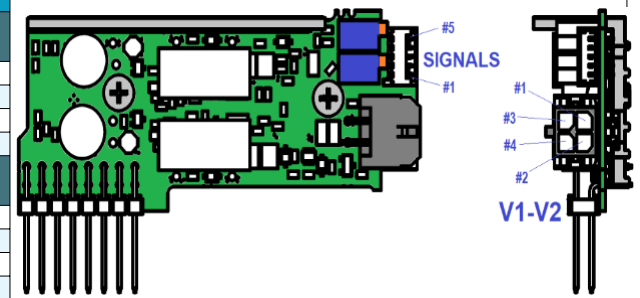

OPW / OPZ Counterpart Connectors				
Reference	Details	Manufacturer	Housing PN	Crimp Terminal PN
V1 /V2 Outputs	Micro-Fit 3.0™ Receptacle Housing, Dual Row, 4 Circuits, Halogen Free. Micro-Fit 3.0™ Crimp Terminal, Female, with Tin (Sn) Plated Phosphor Bronze Contact, 20-24 AWG	Molex	430250400	43030-0001
Signals	1.25mm Pitch PicoBlade™ Wire-to-Wire and Wire-to-Board Housing, Female, 5 Circuits. 1.25mm Pitch PicoBlade™ Crimp Terminal, Female, 28-32 AWG.	Molex	51021-0500	50058-8000

Output Specifications – Module A (RCA-OPA)

Parameter	Test conditions / Notes	Min	Nominal	Max	Units
Output voltage range		1.5	5	7.5	V
Rated current				25	A
Average output power				125	W
Peak output power	<5 s, 50% duty cycle			187.5	W
Initial voltage accuracy	Factory set units, Measured at sense terminals	-0.5		0.5	% V _{SET}
Output voltage adjustment	Manual: 11-turns potentiometer		9.12		V/turn
Load regulation	Measured at sense terminals	-50		50	mV
Line regulation	Measured at sense terminals	-0.1		0.1	%V _{NOM}
Cross regulation	Measured at sense terminals	-0.2		0.2	%V _{NOM}
Minimum load			0		A
Output temperature drift		-0.02		0.02	%/°C
Ripple and Noise	20 MHz bandwidth, peak-peak			1	%V _{NOM}
Transient response	25% to 75% load transient, at 1A/μs, recovery to within 10% of V _{SET}			1 100	V μs
Turn on rise time	Monotonic, 10% to 90%	1.5		3.5	ms
Turn on overshoot				0.1	% V _{SET}
Turn on delay	From AC on to Power Good From Enable to Power Good		600 15	750 20	ms ms
Current sharing accuracy				5	%I _{MAX}
Open sense offset	Open sense, voltage offset due to bias currents			2	%V _{NOM}
Hold-up voltage				6	V
Isolation to ground	Each terminal			250	V
Over current protection	% of rated current	105		125	%I _{RATED}
Reverse current protection	% of rated current	-6		0	%I _{RATED}
Short circuit protection (Hiccup mode)	Period Duty cycle Voltage threshold (at sense)		125 3 1		ms % V
Over voltage protection	Latching		9.5		V
Over temperature protection	Internally monitored, latching	115		125	°C
Sense cable protection	On positive terminal On negative terminal	-1 none		2 1	V
Power good threshold	Low threshold only		90		% V _{SET}
Output current signal	$I_{SGN} = 0.6 + I_{OUT}/(I_{RTD} * 1.25)$	0		110	%I _{RATED}
Current limit control	$I_{LMT} = (V_{CTRL} - 0.6) * I_{RTD} * 1.25$	0		110	%I _{RATED}
Remote voltage control	$V_{OUT} = V_{SET} * ((1.8 - V_{CTRL}) / 0.6)$	0		300	% V _{SET}
Bias supply	10 mA max	4.5	5	5.2	V
Reliability	At 40 °C, 80% load			1	FPMH
Warranty				2	Years
Wire size	Power cables	12	10		AWG
Weight				60	g
Size	60 mm x 35 mm x 17 mm (2.36 in x 1.38 in x 0.67 in)				

Output Specifications – Module B (RCA-OPB)

Parameter	Test conditions / Notes	Min	Nominal	Max	Units
Output voltage range		4.5	12	15	V
Rated current				15	A
Average output power				150	W
Peak output power	<5 s, 50% duty cycle			225	W
Initial voltage accuracy	Factory set units, Measured at sense terminals	-0.5		0.5	% V _{SET}
Output voltage adjustment	Manual: 11-turns potentiometer		15.12		V/turn
Load regulation	Measured at sense terminals	-100		100	mV
Line regulation	Measured at sense terminals	-0.1		0.1	%V _{NOM}
Cross regulation	Measured at sense terminals	-0.2		0.2	%V _{NOM}
Minimum load			0		A
Output temperature drift		-0.02		0.02	%/°C
Ripple and Noise	20 MHz bandwidth, peak-peak			1	%V _{NOM}
Transient response	25% to 75% load transient, at 1A/μs, recovery to within 10% of V _{SET}			1.5 100	V μs
Turn on rise time	Monotonic, 10% to 90%	1.5		3.5	ms
Turn on overshoot				0.1	% V _{SET}
Turn on delay	From AC on to Power Good From Enable to Power Good		600 15	750 20	ms ms
Current sharing accuracy				5	%I _{MAX}
Open sense offset	Open sense, voltage offset due to bias currents			2	%V _{NOM}
Hold-up voltage				12.5	V
Isolation to ground	Each terminal			250	V
Over current protection	% of rated current	105		125	%I _{RATED}
Reverse current protection	% of rated current	-6		0	%I _{RATED}
Short circuit protection (Hiccup mode)	Period Duty cycle Voltage threshold (at sense)		125 3 2		ms % V
Over voltage protection	Latching		18		V
Over temperature protection	Internally monitored, latching	115		125	°C
Sense cable protection	On positive terminal On negative terminal	-1 none		2	V
Power good threshold	Low threshold only		90		% V _{SET}
Output current signal	$I_{SGN} = 0.6 + I_{OUT}/(I_{RTD} * 1.25)$	0		110	%I _{RATED}
Current limit control	$I_{LMT} = (V_{CTRL} - 0.6) * I_{RTD} * 1.25$	0		110	%I _{RATED}
Remote voltage control	$V_{OUT} = V_{SET} * ((1.8 - V_{CTRL}) / 0.6)$	0		300	% V _{SET}
Bias supply	10 mA maximum	4.5	5	5.2	V
Reliability	At 40 °C, 80% load			1	FPMH
Warranty				2	Years
Wire size	Power cables	16	14	10	AWG
Weight				60	g
Size	60 mm x 35 mm x 17 mm (2.36 in x 1.38 in x 0.67 in)				

Output Specifications – Module C (RCA-OPC)

Parameter	Test conditions / Notes	Min	Nominal	Max	Units
Output voltage range		9	24	30	V
Rated current				7.5	A
Average output power				150	W
Peak output power	<5 s, 50% duty cycle			225	W
Initial voltage accuracy	Factory set units, Measured at sense terminals	-0.5		0.5	% V _{SET}
Output voltage adjustment	Manual: 11-turns potentiometer		1.9		V/turn
Load regulation	Measured at sense terminals	-150		150	mV
Line regulation	Measured at sense terminals	-0.1		0.1	%V _{NOM}
Cross regulation	Measured at sense terminals	-0.2		0.2	%V _{NOM}
Minimum load			0		A
Output temperature drift		-0.02		0.02	%/°C
Ripple and Noise	20 MHz bandwidth, peak-peak			1	%V _{NOM}
Transient response	25% to 75% load transient, at 1A/μs, recovery to within 10% of V _{SET}			3	V
Turn on rise time	Monotonic, 10% to 90%	1.5		3.5	ms
Turn on overshoot				0.1	% V _{SET}
Turn on delay	From AC on to Power Good From Enable to Power Good		600 15	750 20	ms ms
Current sharing accuracy				5	%I _{MAX}
Open sense offset	Open sense, voltage offset due to bias currents			2	%V _{NOM}
Hold-up voltage				25	V
Isolation to ground	Each terminal			250	V
Over current protection	% of rated current	105		125	%I _{RATED}
Reverse current protection	% of rated current	-6		0	%I _{RATED}
Short circuit protection (Hiccup mode)	Period Duty cycle Voltage threshold (at sense)		125 3 3.5		ms % V
Over voltage protection	Latching		36		V
Over temperature protection	Internally monitored, latching	115		125	°C
Sense cable protection	On positive terminal On negative terminal	-1 none		2	V
Power good threshold	Low threshold only		90		% V _{SET}
Output current signal	$I_{SGN} = 0.6 + I_{OUT}/(I_{RTD} * 1.25)$	0		110	%I _{RATED}
Current limit control	$I_{LMT} = (V_{CTRL} - 0.6) * I_{RTD} * 1.25$	0		110	%I _{RATED}
Remote voltage control	$V_{OUT} = V_{SET} * ((1.8 - V_{CTRL}) / 0.6)$	0		300	% V _{SET}
Bias supply	10 mA maximum	4.5	5	5.2	V
Reliability	At 40 °C, 80% load			1	FPMH
Warranty				2	Years
Wire size	Power cables	20	18	10	AWG
Weight				60	g
Size	60 mm x 35 mm x 17 mm (2.36 in x 1.38 in x 0.67 in)				

Output Specifications – Module D (RCA-OPD)

Parameter	Test conditions / Notes	Min	Nominal	Max	Units
Output voltage range		18	48	58	V
Rated current				4.12	A
Average output power				150	W
Peak output power	Less than 5 s, 50% duty cycle			225	W
Initial voltage accuracy	Factory set units, Measured at sense terminals	-0.5		0.5	% V _{SET}
Output voltage adjustment	Manual: 11-turns potentiometer		3.6		V/turn
Load regulation	Measured at sense terminals	-300		300	mV
Line regulation	Measured at sense terminals	-0.1		0.1	%V _{NOM}
Cross regulation	Measured at sense terminals	-0.2		0.2	%V _{NOM}
Minimum load			0		A
Output temperature drift		-0.02		0.02	%/°C
Ripple and Noise	20 MHz bandwidth, peak-peak			1	%V _{NOM}
Transient response	25% to 75% load transient, at 1A/μs, recovery to within 10% of V _{SET}			3 100	V μs
Turn on rise time	Monotonic, 10% to 90%	1.5		3.5	ms
Turn on overshoot				0.1	% V _{SET}
Turn on delay	From AC on to Power Good From Enable to Power Good		600 15	750 20	ms ms
Current sharing accuracy				5	%I _{MAX}
Open sense offset	Open sense, voltage offset due to bias currents			2	%V _{NOM}
Hold-up voltage				50	V
Isolation to ground	Each terminal			250	V
Over current protection	% of rated current	105		125	%I _{RATED}
Reverse current protection	% of rated current	-6		0	%I _{RATED}
Short circuit protection (Hiccup mode)	Period Duty cycle Voltage threshold (at sense)		125 3 3.5		ms % V
Over voltage protection	Latching		66		V
Over temperature protection	Internally monitored, latching	115		125	°C
Sense cable protection	On positive terminal On negative terminal	-3 none		3	V
Power good threshold	Low threshold only		90		% V _{SET}
Output current signal	$I_{SGN} = 0.6 + I_{OUT}/(I_{RTD} * 1.25)$	0		110	%I _{RATED}
Current limit control	$I_{LMT} = (V_{CTRL} - 0.6) * I_{RTD} * 1.25$	0		110	%I _{RATED}
Remote voltage control	$V_{OUT} = V_{SET} * ((1.8 - V_{CTRL}) / 0.6)$	0		300	% V _{SET}
Bias supply	10 mA max	4.5	5	5.2	V
Reliability	At 40 °C, 80% load			1	FPMH
Warranty				2	Years
Wire size	Power cables	20	18	10	AWG
Weight				60	g
Size	60 mm x 35 mm x 17 mm (2.36 in x 1.38 in x 0.67 in)				

Output Specifications – Module W (RCA-OPW)

Parameter	Test conditions / Notes	Min	Nominal	Max	Units
Voltage range	Each channel	3.3	12	15	V
Rated current	Each channel			5.0	A
Rated power	Each channel			75	W
Initial voltage accuracy	Factory set units	-1		1	% V _{SET}
Voltage adjustment	Manual: 11-turns potentiometer		1.1		V/turn
Load regulation	Measured at sense terminals	-50		50	mV
Line regulation	Measured at sense terminals	-0.1		0.1	%V _{NOM}
Cross regulation	Measured at sense terminals	-0.2		0.2	%V _{NOM}
Minimum load			0		A
Temperature drift		-0.02		0.02	%/°C
Ripple and Noise	20 MHz bandwidth, peak-to-peak			2	%V _{NOM}
Transient response	V _{SET} : 12 V 25% to 75% load transient, at 1A/μs, recovery to within 10% of V _{SET}			1 200	V μs
Turn on rise time	Monotonic, 10 to 90 %	4.5	5.5	6.5	ms
Turn on overshoot				0.1	% V _{SET}
Turn on delay	From AC on (120 V _{AC}) to Power Good From Enable to Power Good	250 15		350 25	ms
Hold-up voltage				12	V
V1/V2 Isolation to ground	Each terminal			250	V
Isolation V1 to V2	Each terminal			250	V
Over current protection	Hiccup mode	105		125	%I _{RATED}
Reverse current protection	None				%I _{RATED}
Short circuit protection	Hiccup period Hiccup duty cycle		50 25		ms %
Over voltage protection	Latching	19	20	21	V
Over temperature protection	Internally monitored, latching	115		125	°C
Power good threshold	High threshold Low threshold only	90 88	94 92	98 95	% V _{SET}
Reliability	At 40 °C, 80% duty cycle, 100% load Telcordia SR-332 Issue 2			1	FPMH
Warranty				2	Years
Wire size	Power cables	20	18	10	AWG
Size and weight	27.5 x 65.9 x 15.7 mm (1.08 x 2.59 x 0.62 in); 60 g (2.1 oz)				

Output Specifications – Module Z (RCA-OPZ)

Parameter	Test conditions / Notes	Min	Nominal	Max	Units
Voltage range	Each channel	15	24	38	V
Rated current	Each channel at 24V output. De-rating applies over 24V output			5.12	A
Rated power	Each channel			75	W
Initial voltage accuracy	Factory set units	-1		1	% V _{SET}
Voltage adjustment	Manual: 11-turns potentiometer		2.2		V/turn
Load regulation	Measured at sense terminals	-50		50	mV
Line regulation	Measured at sense terminals	-0.1		0.1	%V _{NOM}
Cross regulation	Measured at sense terminals	-0.2		0.2	%V _{NOM}
Minimum load			0		A
Temperature drift		-0.02		0.02	%/°C
Ripple and Noise	20 MHz bandwidth, peak-to-peak			2	%V _{NOM}
Transient response	V _{SET} : 24 V 25% to 75% load transient, at 1A/μs, recovery to within 10% of V _{SET}			1 100	V μs
Turn on rise time	Monotonic, 10 to 90 %	1.5		3.5	ms
Turn on overshoot				0.1	%V _{SET}
Turn on delay	From AC On (120 V _{AC}) to Power Good From Enable to Power Good	250 15		350 25	ms
Hold-up voltage				24	V
V1/V2 Isolation to ground	Each terminal			250	V
Isolation V1 to V2	Each terminal			250	V
Over current protection	Hiccup mode	105		125	%I _{RATED}
Reverse current protection	None				%I _{RATED}
Short circuit protection	Hiccup period Hiccup duty cycle		50 25		ms %
Over voltage protection	Latching	44		46	V
Over temperature protection	Internally monitored, latching	115		125	°C
Power good threshold	High threshold Low threshold only	90 88	94 92	98 95	%V _{SET}
Reliability	At 40 °C, 80% duty cycle, 100% load Telcordia SR-332 Issue 2			1	FPMH
Warranty				2	Years
Wire size	Power cables	20	18	10	AWG
Size and weight	27.5 x 65.9 x 15.7 mm (1.08 x 2.59 x 0.62 in); 60 g (2.1 oz)				

Specifications appearing in Inission's catalogues and brochures as well as any oral statements are not binding. All descriptions, drawings and other particulars (including dimensions, materials and performance data) given by Inission are as accurate as possible but, being given for general information, and are not binding on Inission. Inission makes thus no representation or warranty as to the accuracy of such material. We assume no liability other than as agreed in the terms of the individual contracts and we reserve the right to make technical modifications in the course of our product development. Our product information solely describes our goods and

services and is in no way to be construed or interpreted as a quality or condition guarantee. The aforesaid shall not relieve the customer of its obligation to verify the suitability of our Products for the use or application intended by the purchaser. Customers are responsible for their products and applications. Inission assumes no liability from the use of its products outside of specifications. No license is granted to any intellectual property rights by this document.